

TENDANCE

"Le simplicité est la sophistication suprême" — Léonard de Vinci

GAMME TENDANCE QUALITÉ ET PRIX



Limitée à l'essentiel et concentrée sur la fonctionnalité, la conception de cette gamme respecte les objectifs économiques

Toujours assemblé sur le principe du tenon/mortaise ; plein, ajouré ou mixte, lames étroites ou larges, verticales ou horizontales, les remplissages permettent d'ajuster le degré d'intimité.

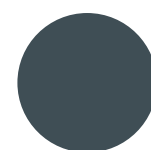

RAL 7016
givré

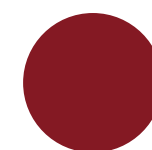

RAL 3004
givré

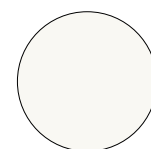

RAL 9010
givré



RAL 7035
givré



PORTAILS

TENDANCE

"La simplicité est la sophistication suprême"
Léonard de Vinci

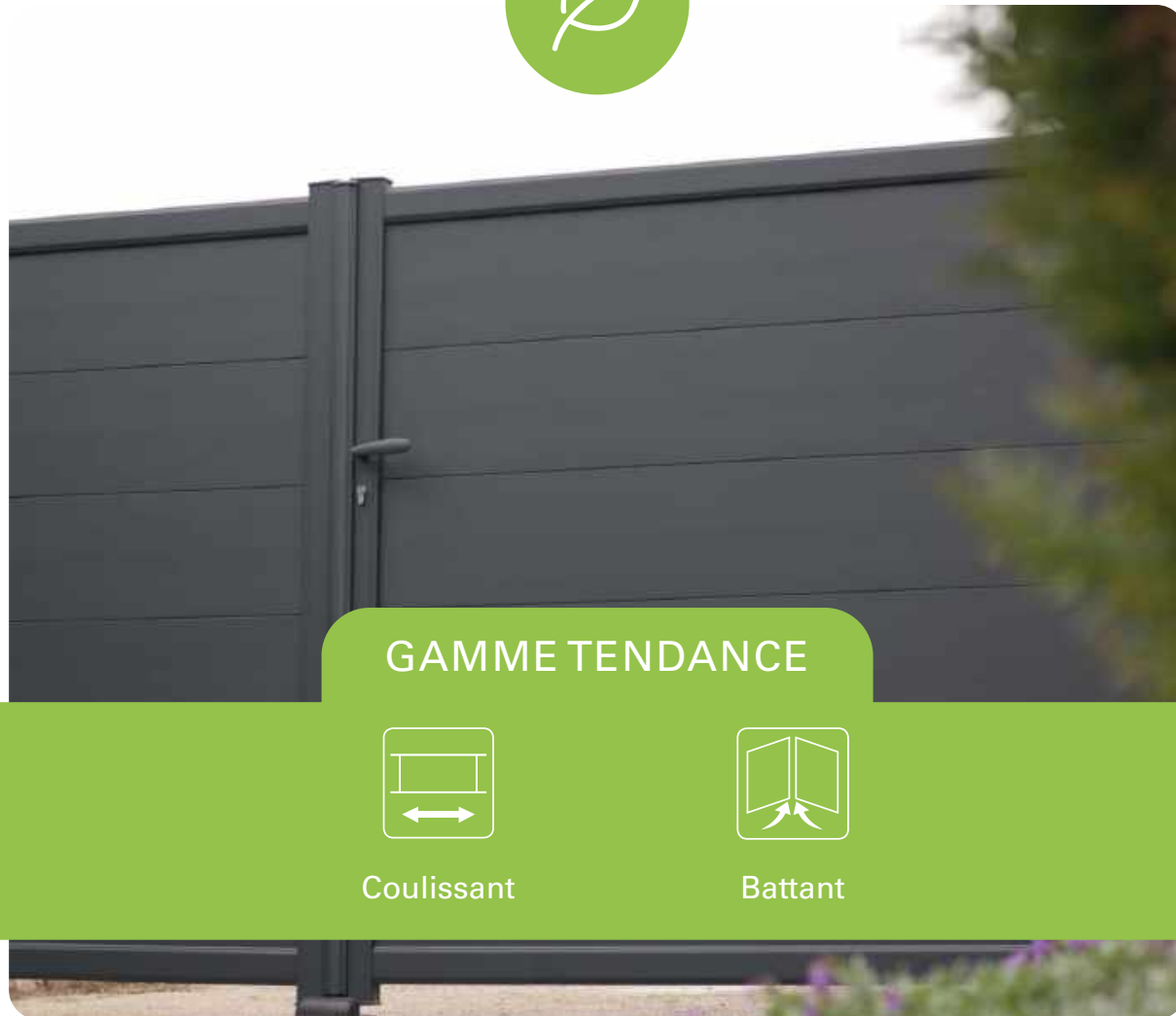

GAMME TENDANCE



Coulissant



Battant

closura.com

CS : Coulissant

BA : Battant

TENDANCE

FASHION

CS + BA

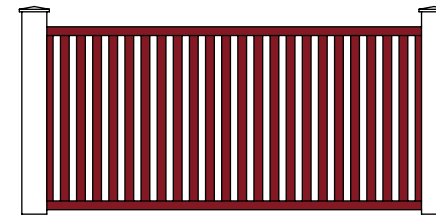

CS 1101

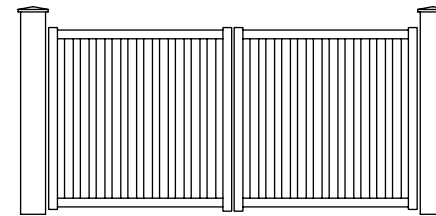

BA 1101



BA 1101

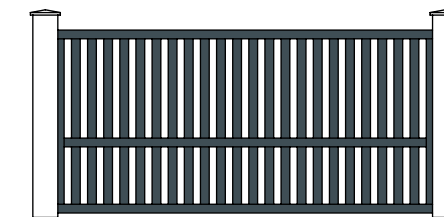

CS 1111

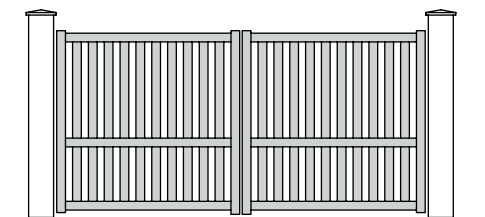

BA 1111



BA 1116

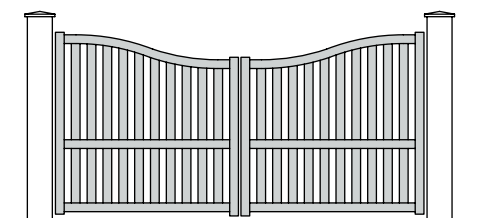

BA 1117

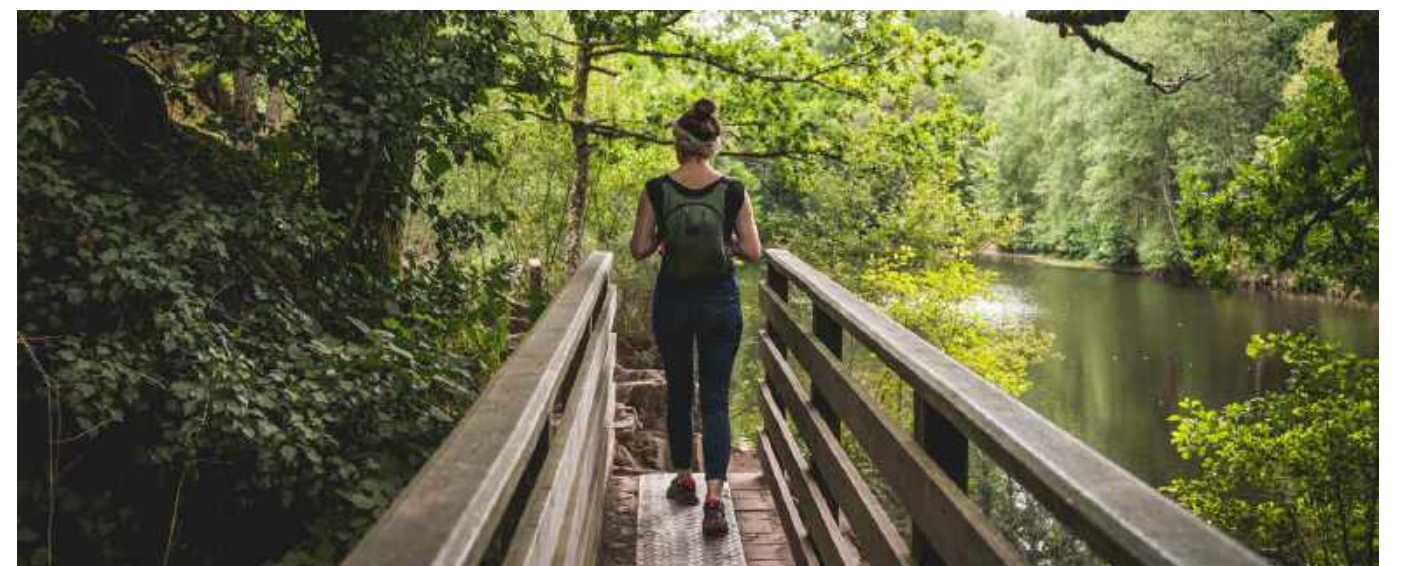

VINTAGE

CS + BA

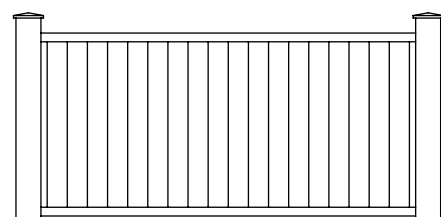

CS 1201



CS 1208



Zoom sur BA 1208



BA 1201



BA 1208

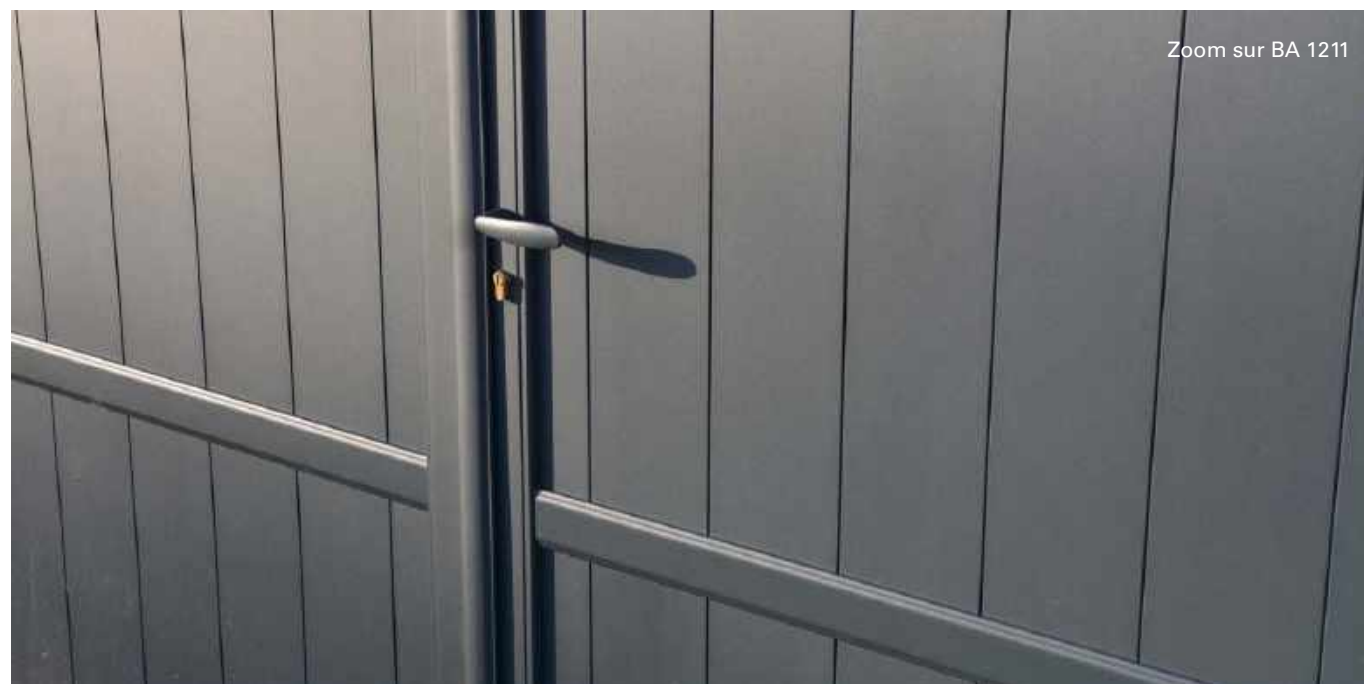

Zoom sur BA 1211

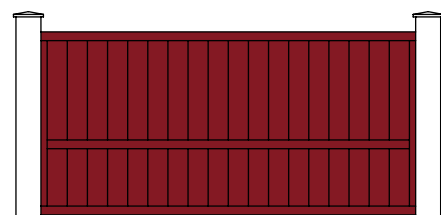

CS 1211



BA 1211



BA 1218

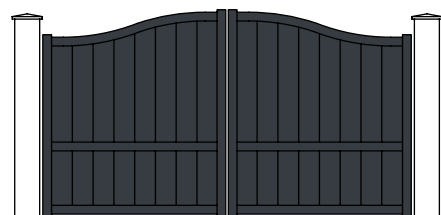

BA 1216

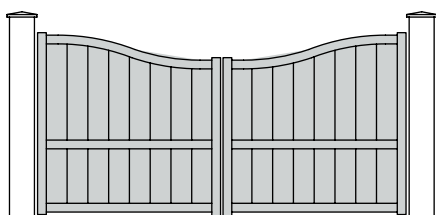

BA 1217

ÉPURE - Lames 250 mm*

* Uniquement 3 coloris (9010 G, 7016 G, 7035 G)

CS + BA



CS 1288

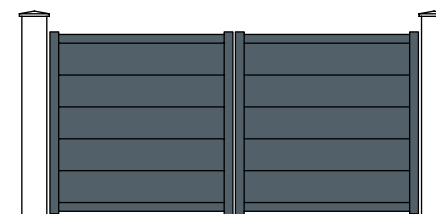

BA 1288



CS 1288
Montant central largeur > 3 250 mm

TECHNO

CS + BA

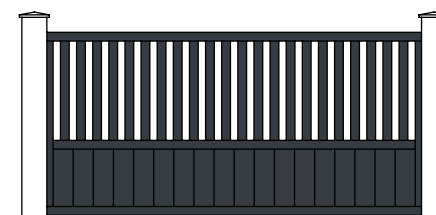

CS 1311

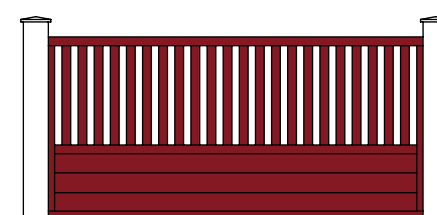

CS 1318

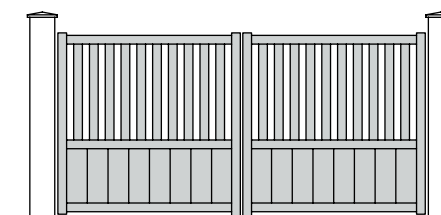

BA 1311

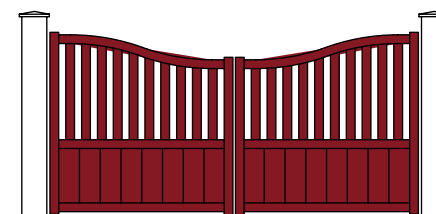

BA 1317

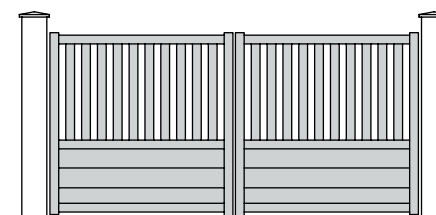

BA 1318



BA 1316



CS : Couissant



BA : Battant

TENDANCE

TENDANCE

DÉCO

CS + BA

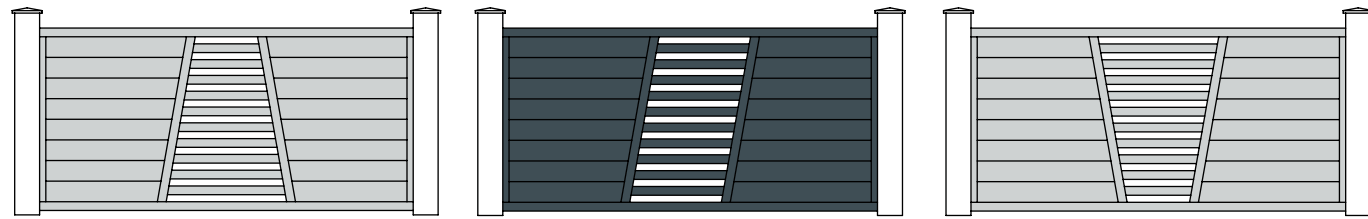

CS 1354

CS 1355

CS 1356

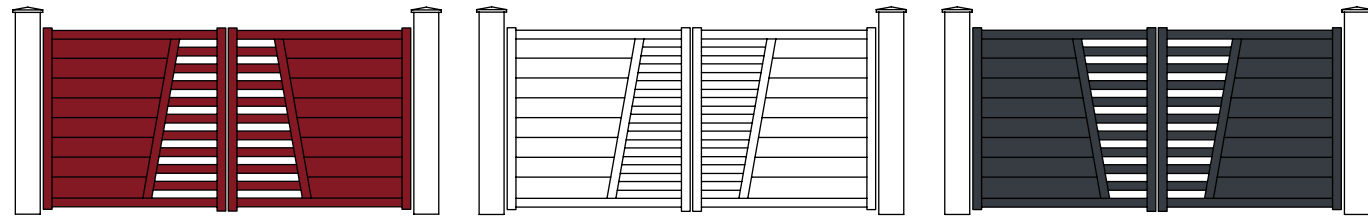

BA 1354

BA 1355

BA 1356



BA 1288 - Lames de 250 mm



CS 1355



CS 1288 - Lames de 250 mm
Poteaux aluminium de 150 x 150 mm
Montant central > 3 250 mm



L'aluminium : matériau recyclable

En effet il est 100% recyclable, infiniment, sans perte de ses qualités physico-chimiques.



Durabilité et assemblage

L'assemblage de nos portails est réalisé par emboîtement des profils sur 62 mm pour les portails battants et 12 mm pour les coulissants afin d'obtenir une résistance maximale. L'ensemble est vissé par des vis inox.



Structure et design

Les profils constitutifs de nos portails sont de forte section, ce qui confère : solidité et esthétique.

DIMENSIONS PORTAILS TENDANCE

	BATTANTS	COULISSANTS
Montant	70 x 45 mm	70 x 35 mm
Traverse haute	70 x 35 mm	70 x 79 mm
Traverse intermédiaire	70 x 35 mm	70 x 26 mm
Traverse basse	70 x 35 mm	70 x 45 mm
Barreau	70 x 15 mm	70 x 15 mm
Remplissage	163 x 15 mm	163 x 15 mm
Remplissage ÉPURE	250 x 15 mm	250 x 15 mm

Nos thermolaquages (projection de poudre à haute pression sur les profils aluminium, puis cuisson au four) sont garantis 25 ans et bénéficient du label QUALICOAT et QUALICOAT SEASIDE.



Coupe B-B

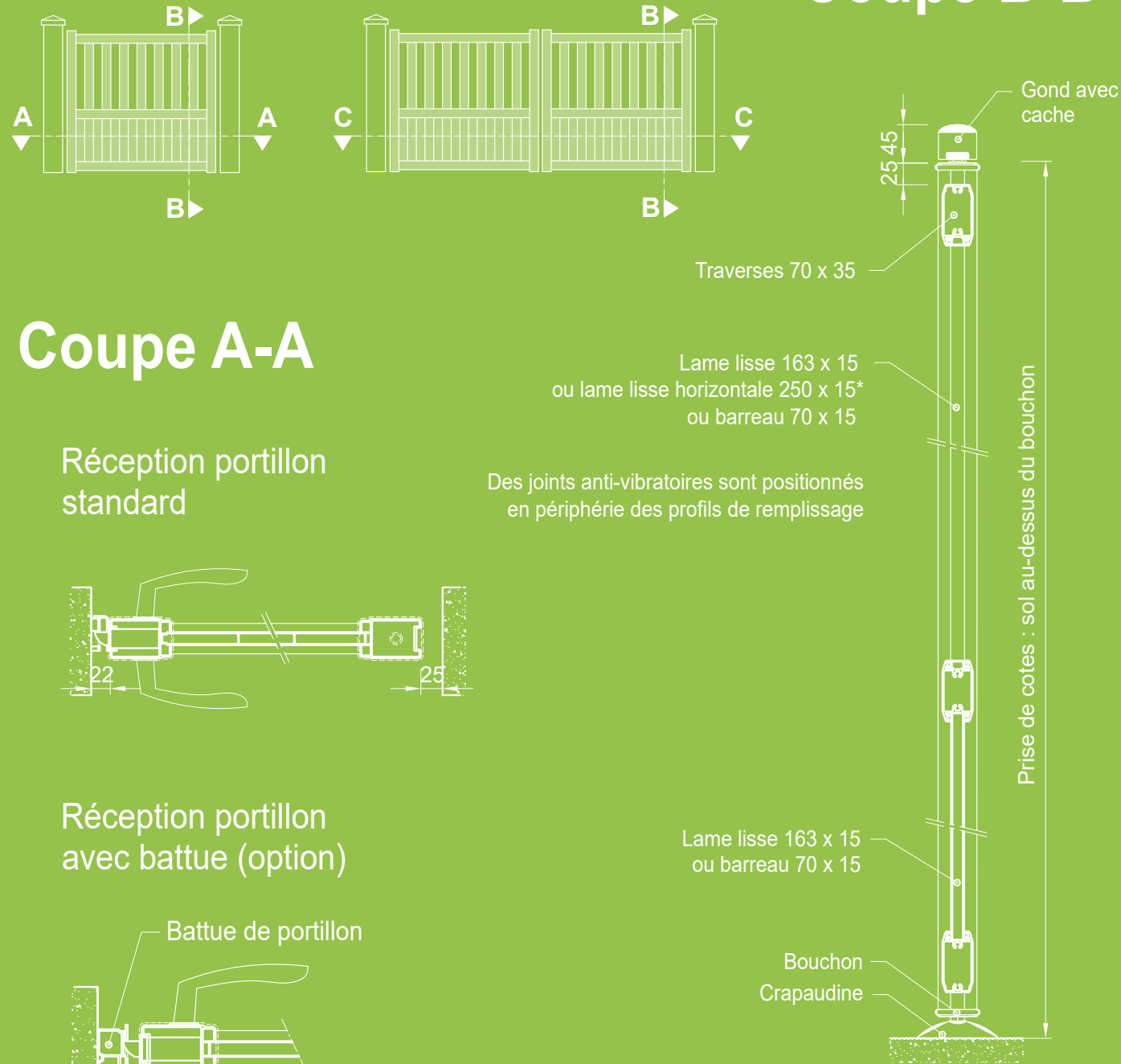

Coupe C-C

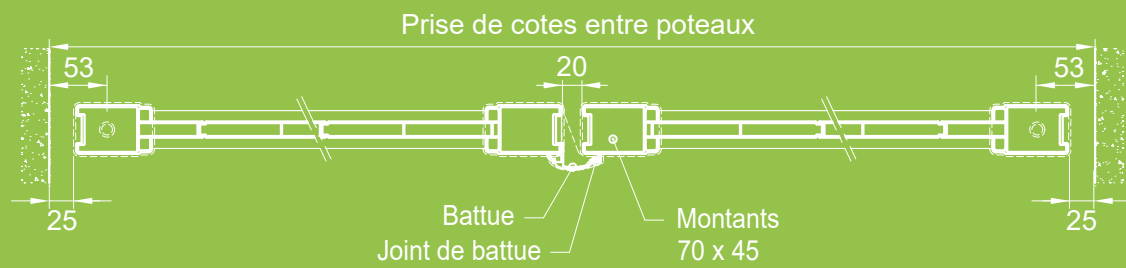

* uniquement en 3 coloris 9010 G, 7035 G ou 7016 G

BATTANT

GAMME TENDANCE

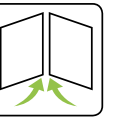

Les composants

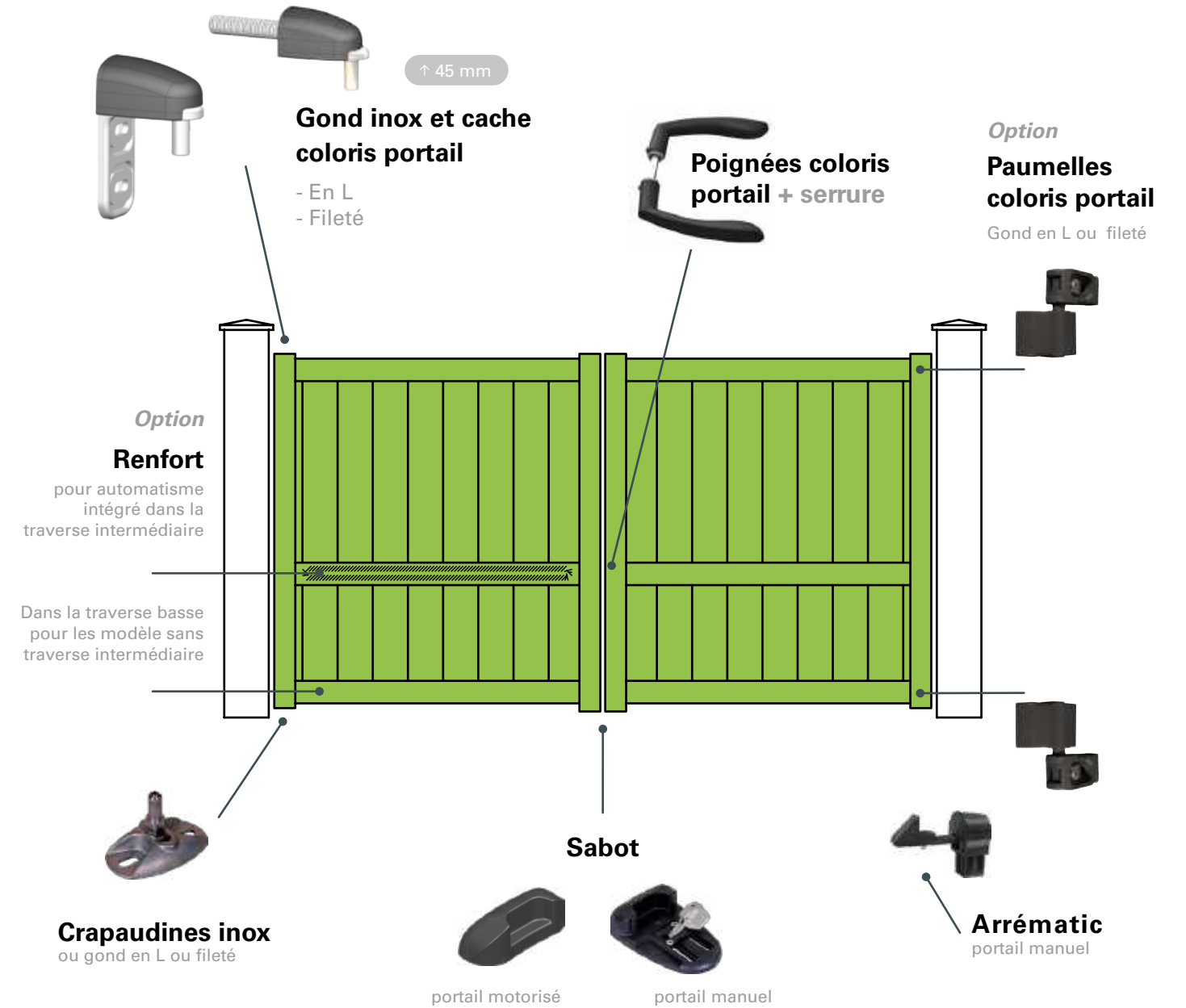

Les options supplémentaires

Régulateur de pente



Pattes à 180°



Gâche électrique



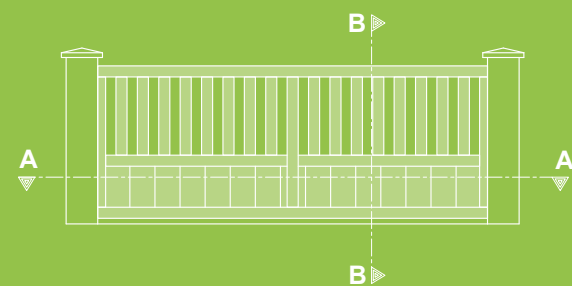

Coupe B-B

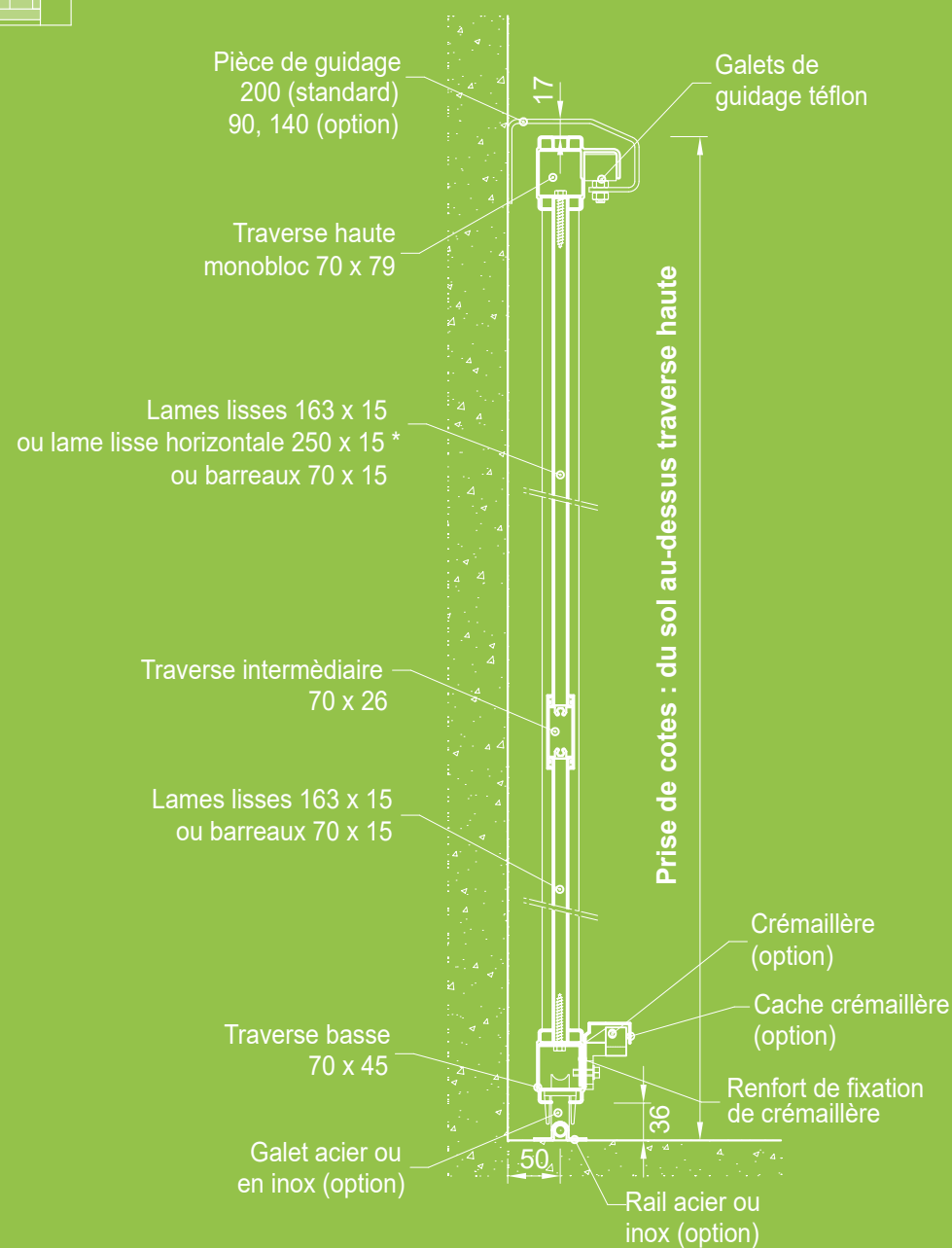

Des joints anti-vibratoires sont positionnés en périphérie des profils de remplissage

Coupe A-A

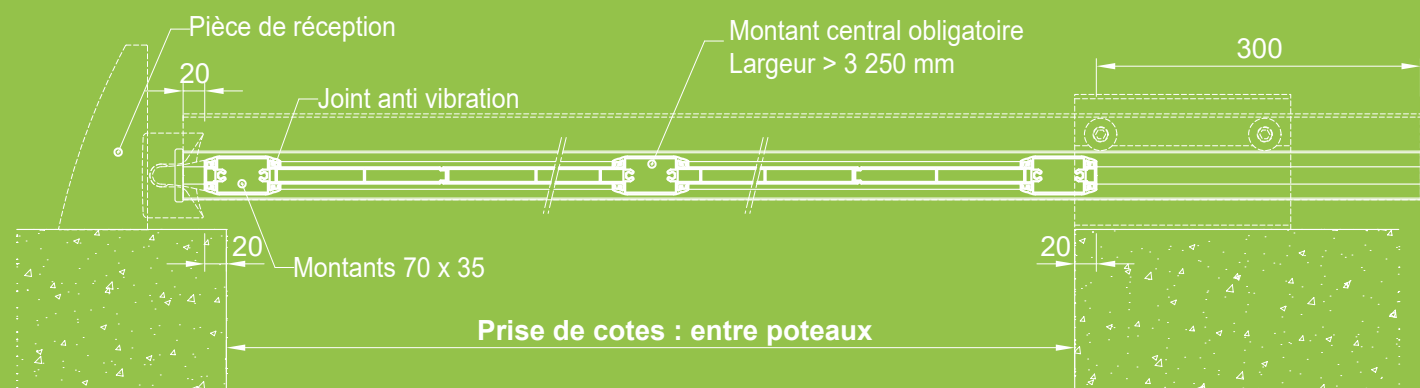

COULISSANT

GAMME TENDANCE

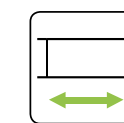

Les composants

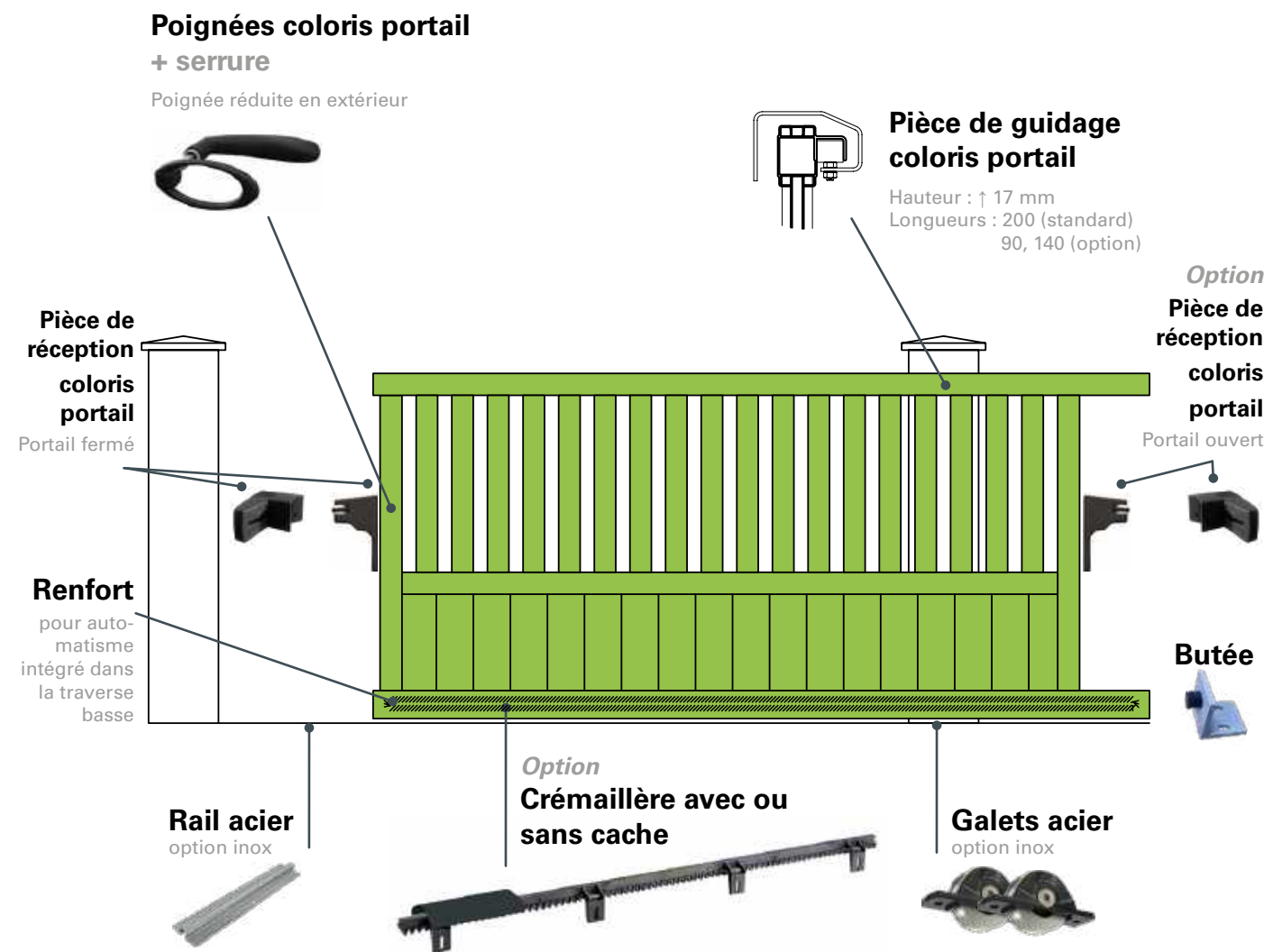

L'option supplémentaire

Pièce de guidage réglable
Longueur : 200 (standard)
140 (option)



* uniquement en 3 coloris (9010 G, 7035 G ou 7016 G)

POTEAUX & POTELETS

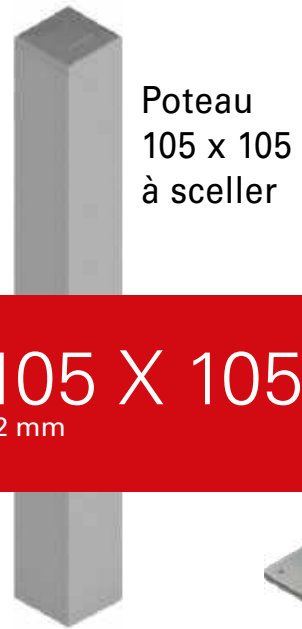

Poteau
105 x 105
à sceller

105 X 105
2 mm



Poteau
105 x 105
sur platine

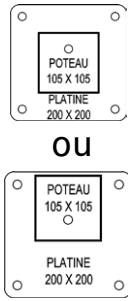

OU

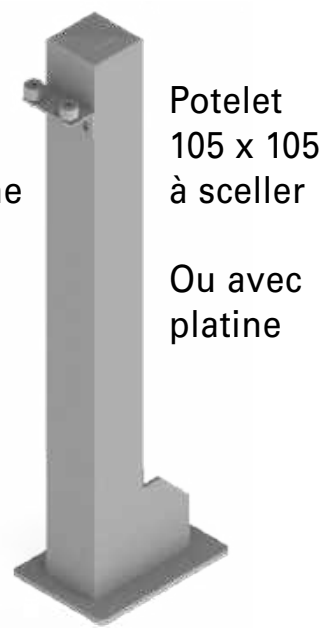
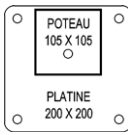

Potelet
105 x 105
à sceller

Ou avec
platine

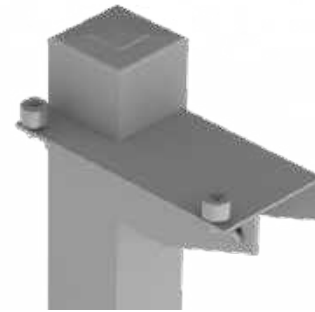

Option
équerre de
guidage de
305 mm



150 X 150
4 mm

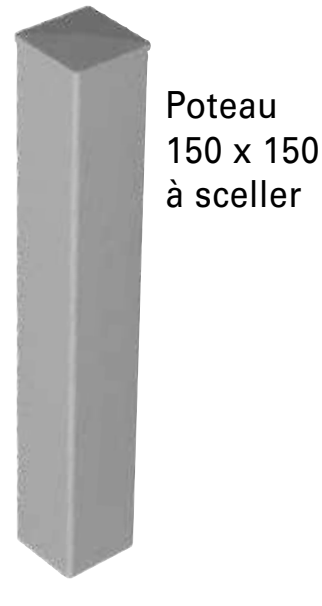

Poteau
150 x 150
à sceller

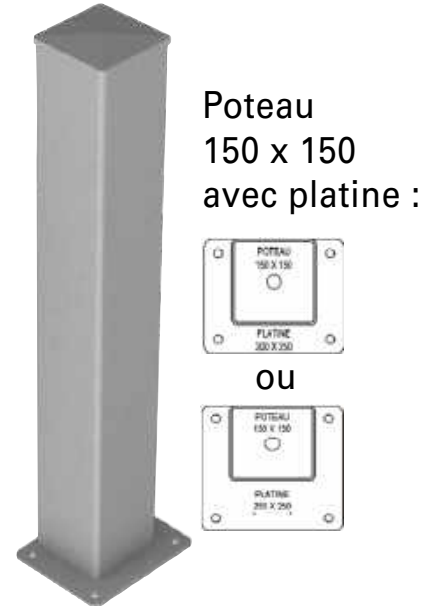

Poteau
150 x 150
avec platine :

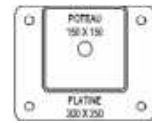

OU

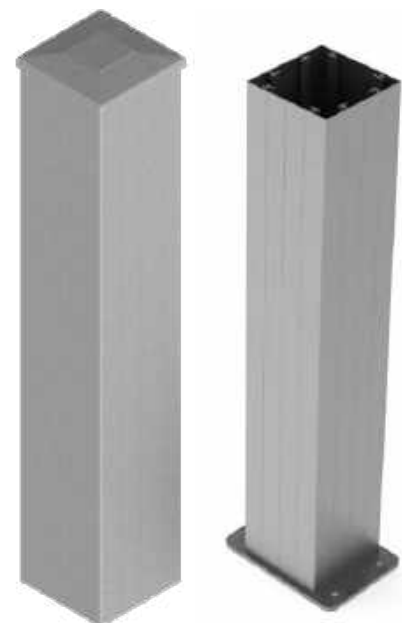
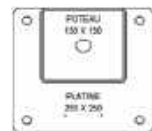

Poteau
180 x 180

Avec ou
sans platine

180 X 180
3 mm

